

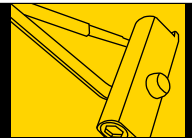

DOOR CLOSERS



Performance Features

- Fully adjustable from 1 - 6 allowing for maximum flexibility.
- All-weather fluid ensures optimal operational performance in multiple climate conditions.
- Delayed action and backcheck are standard in the same door closer body.

Certifications



- ANSI/BHMA A156.4 Series – Grade 1
- ANSI A117.1 Accessibility Code (ADA Compliant)
- UL/cUL listed (3 hour) for self closing
- UL10C Positive Pressure Rated
- UL10B Pressure Rated

Product Specifications

- Handing – All QDC100 Series Closers are non-handed (QDC116 arms & metal covers are handed).
- Cast-iron closer body.
- All-weather fluid.
- Stacked valves prevent oil leaks from screws being backed out too far.
- Cover – metal and plastic covers available.
- Arms & brackets – Tri-pack standard, additional arms optional.
- Arm material – Heat-treated carbon steel.
- Springs – High-impact hand-drawn steel wires.
- Pinions – Heat-treated chrome molybdenum steel.
- Cylinder construction – Heat-treated free-cutting carbon steel.
- Fasteners – Wood and machine screws standard; sex nuts and self-reaming, self-tapping screws shipped standard.
- Door weights & sizes:

Size	Applicable Door Weight	Door Width Ranges	
		Interior	Exterior
1	33 – 55 LBS (15 – 30 Kg)	32" (0.81m)	28" (0.71m)
2	56 – 99 LBS (30 – 45 Kg)	36" (0.91m)	32" (0.81m)
3	99 – 143 LBS (45 – 65 Kg)	42" (1.07m)	36" (0.91m)
4	143 – 187 LBS (65 – 85 Kg)	48" (1.22m)	42" (1.07m)
5	187 – 264 LBS (85 – 120 Kg)	54" (1.37m)	48" (1.22m)
6*	264 – 330 LBS (120 – 150 Kg)	58" (1.47m)	54" (1.32m)

*50% spring power adjustment over size 6.

Warranty

- Lifetime Mechanical and 3-year finish

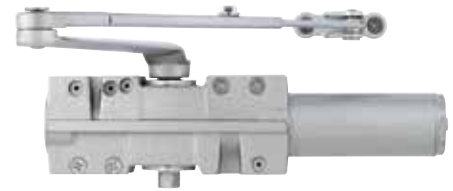

QDC111



Rounded Plastic Cover (R)
(Ships Standard)



Metal Cover (M)
(Left hand shown)

Door Closer Functions

Series	Description
QDC111	Tri-Pack Arm
QDC112	Tri-Pack Arm with Hold-Open
QDC113	Extra Duty Arm with Compression Stop
QDC114	Extra Duty Arm with Hold-Open and Compression Stop
QDC115	Extra Duty Arm
QDC116	Extra Duty Arm with Hold-Open (handed)
QDC117	Extra Duty Arm with Stop
QDC118	Extra Duty Arm with Hold-Open and Stop
QDC119	Extra Duty Arm with Spring Stop
QDC120	Extra Duty Arm with Hold Open and Spring Stop

Finishes

BHMA	Description
689	Painted Aluminum
690	Painted Dark Bronze
696	Painted Satin Brass

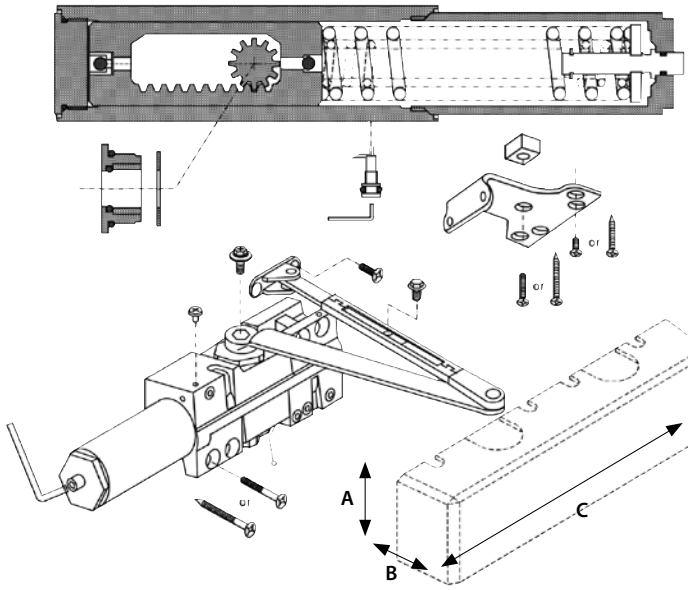

DOOR CLOSERS

QDC
100 Series Grade 1
Extra Heavy-Duty Door Closers



DIMENSIONS		
A	B	C
3.50"	2.25"	12.1875"
88.90mm	57.15mm	309.56mm

Model/ Series	Functions	Case Qty
QDC111	Tri-Pack Arm	3
QDC112	Tri-Pack Arm with Hold-Open	1
QDC113	Extra Duty Arm with Compression Stop	1
QDC114	Extra Duty Arm with Hold-Open and Compression Stop	1
QDC115	Extra Duty Arm	1
QDC116	Extra Duty Arm with Hold-Open (handed)	1
QDC117	Extra Duty Arm with Stop	1
QDC118	Extra Duty Arm with Hold-Open and Stop	1
QDC119	Extra Duty Arm with Spring Stop	1
QDC120	Extra Duty Arm with Hold Open and Spring Stop	1

Order with Closer	Description	Service Part #
	Sex nuts (Qty 4) (specify finish)	8Q00097
	Self-reaming, self-tapping screws (specify finish)	8Q00547
M	QDC100 Series Metal Cover - RH	8Q01140
M	QDC100 Series Metal Cover - LH	8Q01141

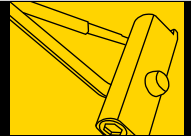

11	Tri-Pack Arm				
12	Tri-Pack Arm with Hold-Open				
13	Extra Duty Arm with Compression Stop				
14	Extra Duty Arm with Hold-Open and Compression Stop				
15	Extra Duty Arm				
16	Extra Duty Arm with Hold-Open				
17	Extra Duty Arm with Stop				
18	Extra Duty Arm with Hold-Open and Stop	689	Painted Aluminum	QDC 116 HEDA Arm and Metal Cover Only	
19	Extra Duty Arm with Spring Stop	690	Painted Dark Bronze	LH	Left Hand
20	Extra Duty Arm with Hold Open and Spring Stop	696	Painted Satin Brass	RH	Right Hand

Base Part Number					
Series	Function	Trim	Finish	Options	Handing
QDC1	11	R	689	BF	

QDC1xx	Grade 1 Extra Heavy-Duty Architectural
--------	--

R	Full-Size Rounded Plastic Cover
M	Full-Size Metal Cover

BF	Barrier Free
----	--------------

Example

If you ordered: QDC111R 689 BF RH

You would get: Grade 1 Extra Duty Door Closer – Full Adjustable (Sized 1-6), Tri-Pack Arm, Rounded Plastic Cover, Barrier Free, Painted Aluminum Finish

Performance Features

- Fully adjustable from 1 - 6 allowing for maximum flexibility.
- Delayed action and backcheck are standard in the same door closer body.
- All-weather fluid ensures optimal operational performance in multiple climate conditions.

Certifications



- ANSI/BHMA A156.4 Series – Grade 1
- ANSI A117.1 Accessibility Code (ADA Compliant)
- UL/cUL listed (3 hour) for self-closing doors without hold open
- UL10C Positive Pressure Rated
- UL10B Pressure Rated

Product Specifications

- Handing – All QDC200 Series Closers are non-handed.
- Material – Cast aluminum closer body.
- All-weather fluid.
- Cover – Slim-line plastic cover standard. Full, architectural plastic cover also available.
- Arms & brackets – Tri-pack standard (regular, top jamb, parallel configurations). Hold open and dead stop arms also available.
- Arm material – Heat-treated carbon steel.
- Springs – High-impact hand-drawn steel wires.
- Pinions – Heat-treated chrome molybdenum steel.
- Cylinder construction – Heat-treated free-cutting carbon steel.
- Fasteners – Wood and machine screws standard; sex nuts and self-reaming, self-tapping screws shipped standard.
- Door weights & sizes:

Size	Applicable Door Weight	Door Width Ranges	
		Interior	Exterior
1	33 – 55 LBS (15 – 30 Kg)	32" (0.81m)	28" (0.71m)
2	56 – 99 LBS (30 – 45 Kg)	36" (0.91m)	32" (0.81m)
3	99 – 143 LBS (45 – 65 Kg)	42" (1.07m)	36" (0.91m)
4	143 – 187 LBS (65 – 85 Kg)	48" (1.22m)	42" (1.07m)
5	187 – 264 LBS (85 – 120 Kg)	54" (1.37m)	48" (1.22m)
6	264 – 330 LBS (120 – 150 Kg)	58" (1.47m)	54" (1.32m)

Warranty

- Lifetime Mechanical and 3-year finish



Tri-Pack Arm



Tri-Pack Arm with Hold-Open



Heavy Duty Arm with Compression Stop



Heavy Duty Arm with Hold-Open and Compression Stop

Door Closer Functions

Series	Description
QDC211	Tri-Pack Arm
QDC212	Tri-Pack Arm with Hold-Open
QDC213	Heavy Duty Arm with Compression Stop
QDC214	Heavy Duty Arm with Hold-Open and Compression Stop



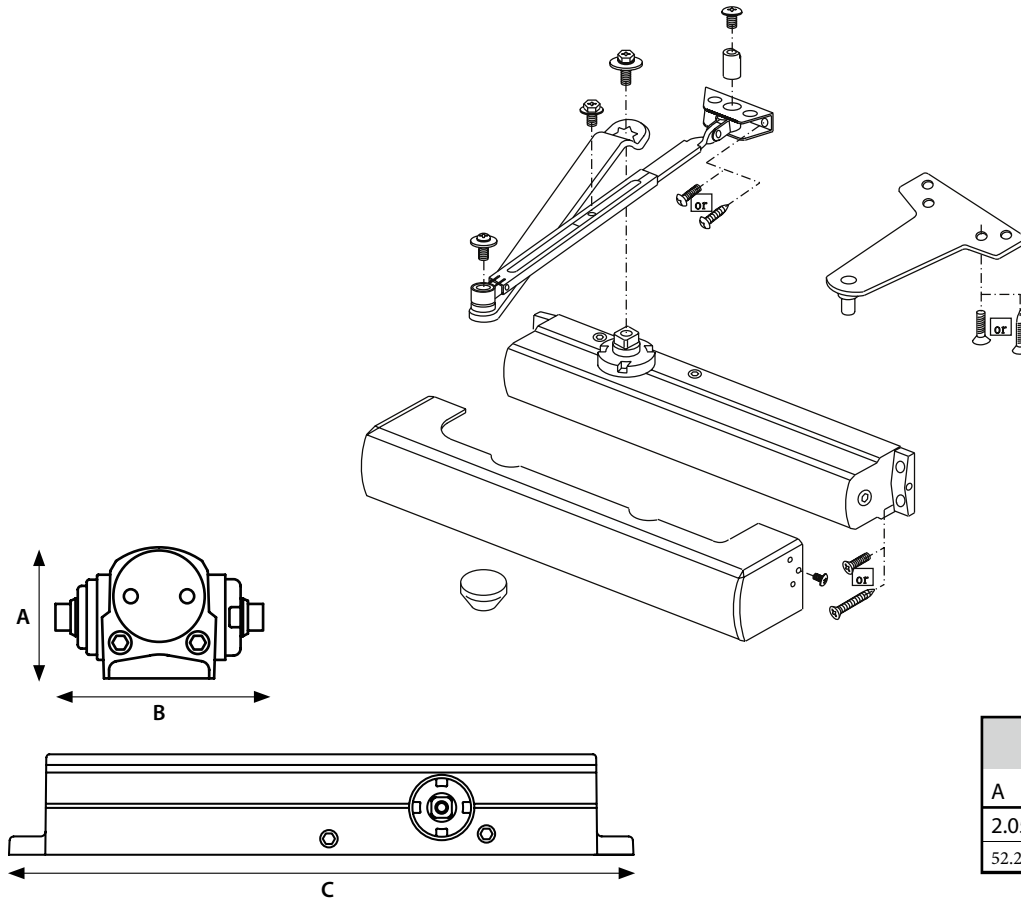
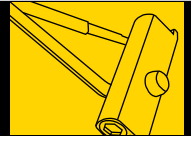

Finishes

BHMA	Description
689	Painted Aluminum
690	Painted Dark Bronze
696	Painted Satin Brass



DIMENSIONS		
A	B	C
2.05"	3.18"	12"
52.20mm	80.70mm	305mm

Model/Series	Functions	Qty
QDC211	Tri-Pack Arm	6
QDC212	Tri-Pack Arm with Hold-Open	6
QDC213	Heavy Duty Arm with Compression Stop	3
QDC214	Heavy Duty Arm with Hold-Open and Compression Stop	3

Order with Closer	Description	Service Part #
 F	Full-size cover (specify finish)	8Q00094
 S	Slim-line cover (specify finish)	8Q00096
	Sex nuts (Qty 4) (specify finish)	8Q00097
	Self-reaming, self-tapping screws (Qty 8) (specify finish)	8Q00436

DOOR CLOSERS

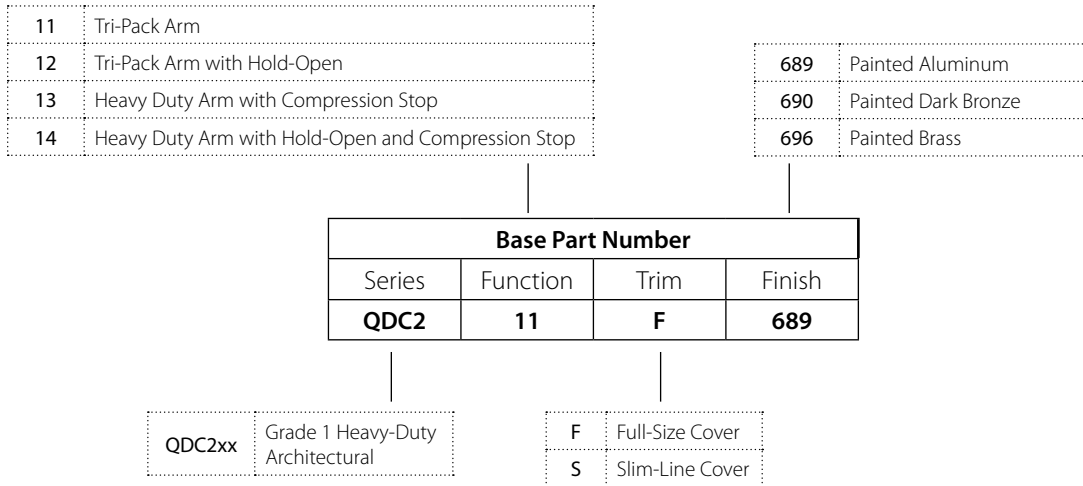

Example

If you ordered: QDC211 F 689

You would get: Grade 1 Heavy-Duty Slim-Line Non-Hold Open Door Closer – Full Adjustable (Sized 1-6), Tri-Packed Arms with both Delayed Action & Backcheck Standard, full-size cover, Painted Aluminum finish.

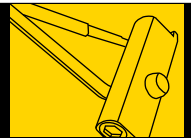

Performance Features

- Fully adjustable from 1 - 6 allowing for maximum flexibility.
- Delayed action and backcheck are standard in the same door closer body.
- All-weather fluid ensures optimal operational performance in multiple climate conditions.

Certifications



- ANSI/BHMA A156.4 Series – Grade 1
- ANSI A117.1 Accessibility Code (ADA Compliant)
- UL/cUL listed (3 hour) for self-closing doors without hold open
- UL10C Positive Pressure Rated
- UL10B Pressure Rated

Product Specifications

- Handing – All QDC300 Series Closers are non-handed.
- Material – Cast aluminum closer body.
- All-weather fluid.
- Cover – Full, architectural plastic cover also available.
- Arms & brackets – Tri-pack standard (regular, top jamb, parallel configurations). Hold open and dead stop arms also available.
- Arm material – Heat-treated carbon steel.
- Springs – High-impact hand-drawn steel wires.
- Pinions – Heat-treated chrome molybdenum steel.
- Cylinder construction – Heat-treated free-cutting carbon steel.
- Fasteners – Wood and machine screws standard; sex nuts and self-tapping screws shipped standard.
- Door weights & sizes:

Size	Applicable Door Weight	Door Width Ranges	
		Interior	Exterior
1	33 – 55 LBS (15 – 30 Kg)	32" (0.81m)	28" (0.71m)
2	56 – 99 LBS (30 – 45 Kg)	36" (0.91m)	32" (0.81m)
3	99 – 143 LBS (45 – 65 Kg)	42" (1.07m)	36" (0.91m)
4	143 – 187 LBS (65 – 85 Kg)	48" (1.22m)	42" (1.07m)
5	187 – 264 LBS (85 – 120 Kg)	54" (1.37m)	48" (1.22m)
6	264 – 330 LBS (120 – 150 Kg)	58" (1.47m)	54" (1.32m)

Warranty

- Lifetime Mechanical and 3-year finish



Tri-Pack Arm



Tri-Pack Arm with Hold-Open



Heavy Duty Arm with Compression Stop



Heavy Duty Arm with Hold-Open and Compression Stop

Door Closer Functions

Series	Description
QDC311	Tri-Pack Arm
QDC312	Tri-Pack Arm with Hold-Open
QDC313	Heavy Duty Arm with Compression Stop
QDC314	Heavy Duty Arm with Hold-Open and Compression Stop

Finishes

BHMA	Description
689	Painted Aluminum
690	Painted Dark Bronze
696	Painted Satin Brass



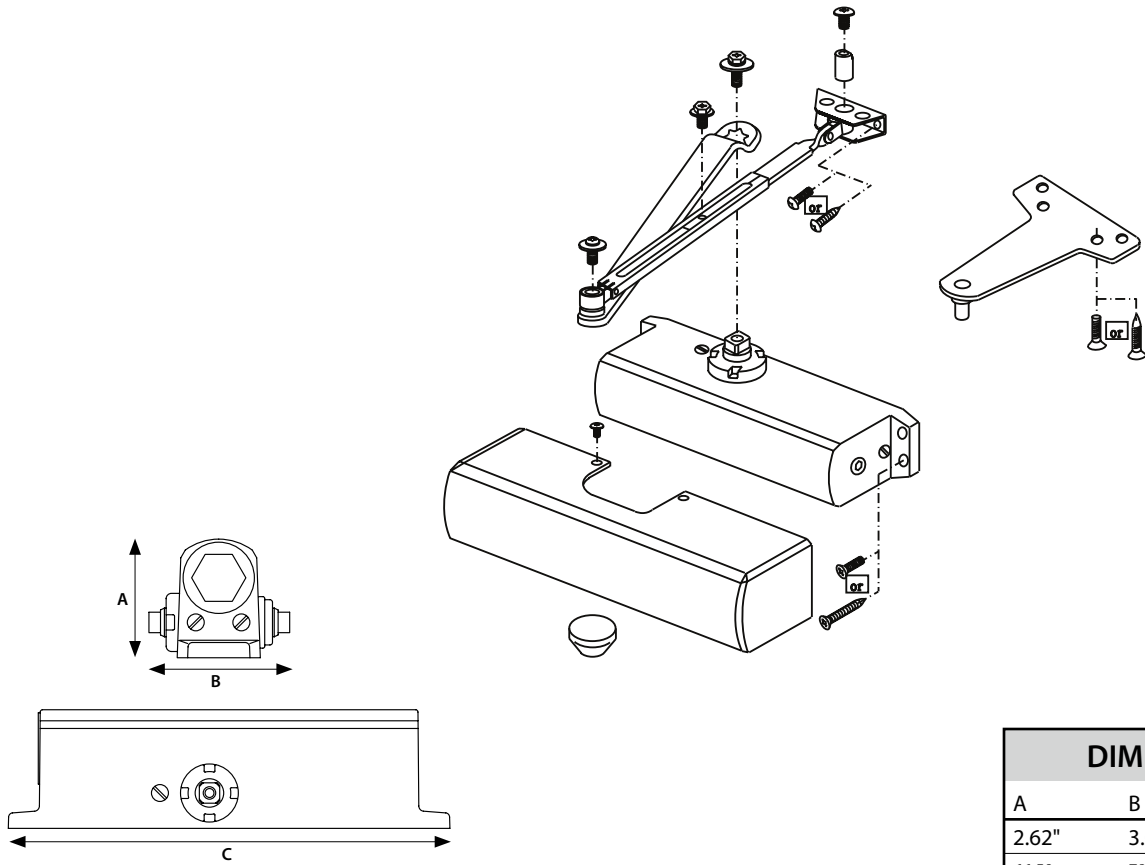

DOOR CLOSERS

QDC
300 Series Grade 1
Standard-Duty Door Closers



DIMENSIONS		
A	B	C
2.62"	3.08"	9.80"
66.50mm	78.10mm	249mm

Model/Series	Functions	Qty
QDC311	Tri-Pack Arm	6
QDC312	Tri-Pack Arm with Hold-Open	6
QDC313	Heavy Duty Arm with Compression Stop	3
QDC314	Heavy Duty Arm with Hold-Open and Compression Stop	3

Order with Closer	Description	Service Part #
 F	Full-size cover (specify finish)	8Q00094
 S	Slim-line cover (specify finish)	8Q00096
	Sex nuts (Qty 4) (specify finish)	8Q00097
	Self-tapping screws (Qty 8) (specify finish)	8Q00436

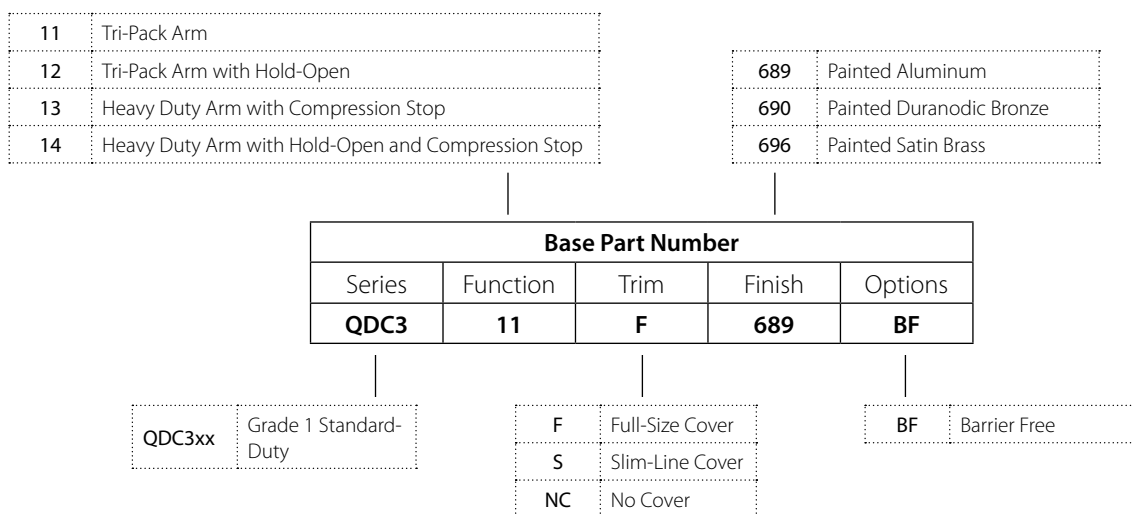
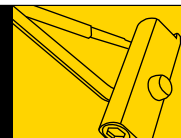

Example

If you ordered: QDC311 F 689 BF

You would get: Grade 1 Standard-Duty Non-Hold Open Door Closer – Full Adjustable (Sized 1-6), Tri-Packed Arms with Both Delayed Action & Backcheck Standard, full-size cover, Painted Aluminum finish, and Barrier Free.